

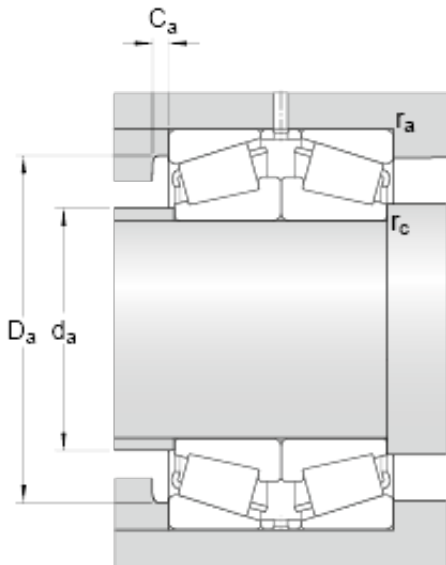

GF BEARING-SINGAPORE LTD.



30312/DF Bearing 2D drawings and 3D CAD models

skf 30312/DF Matched Single row tapered roller bearings arranged face-to-face

Bearing No. 30312/DF

d	60 mm
D	130 mm
T	67 mm
2B	62 mm
b	9 mm
K	6 mm
$r_{3,4}$ min.	2.5 mm
r_5 min.	1 mm
d_a max.	77 mm
D_a min.	112 mm
D_a max.	119.5 mm
C_a min.	5 mm
r_a max.	2.5 mm
r_c max.	1 mm
Basic dynamic load rating C	357 kN
Basic static load rating C_0	390 kN
Fatigue load limit P_u	47.5 kN
Reference speed	3600 r/min
Limiting speed	5300 r/min
Calculation factor e	0.35
Calculation factor Y_1	1.9
Calculation factor Y_2	2.9
Calculation factor Y_0	1.8
Mass bearing pair	4.1 kg