

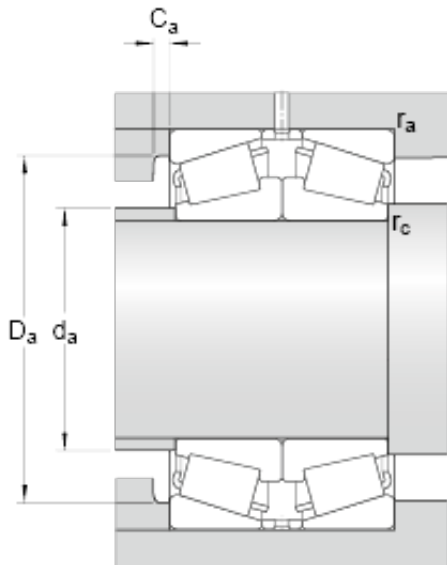

GF BEARING-SINGAPORE LTD.



30230/DF Bearing 2D drawings and 3D CAD models

skf 30230/DF Matched Single row tapered roller bearings arranged face-to-face

Bearing No. 30230/DF

d	150 mm
D	270 mm
T	98 mm
2B	90 mm
b	15 mm
K	10 mm
$r_{3,4}$ min.	3 mm
r_5 min.	1 mm
d_a max.	176 mm
D_a min.	234 mm
D_a max.	256 mm
C_a min.	9 mm
r_a max.	3 mm
r_c max.	1 mm
Basic dynamic load rating C	781 kN
Basic static load rating C_0	1120 kN
Fatigue load limit P_u	114 kN
Reference speed	1400 r/min
Limiting speed	2400 r/min
Calculation factor e	0.43
Calculation factor Y_1	1.6
Calculation factor Y_2	2.3
Calculation factor Y_0	1.6
Mass bearing pair	22.1 kg