

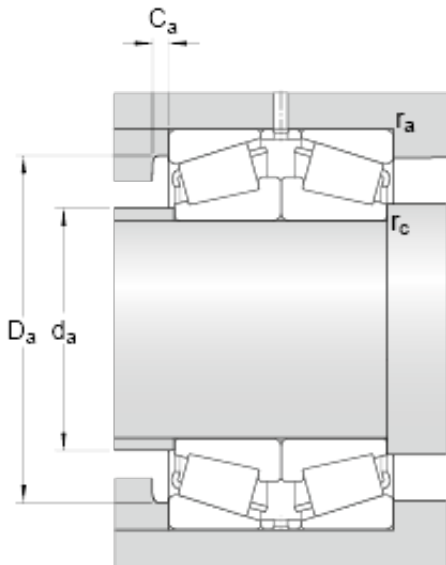

# GF BEARING-SINGAPORE LTD.



30307/DF Bearing 2D drawings and 3D CAD models

skf 30307/DF Matched Single row tapered roller bearings arranged face-to-face

Bearing No. 30307/DF

d	35 mm
D	80 mm
T	45.5 mm
2B	42 mm
b	5 mm
K	3 mm
$r_{3,4}$ min.	1.5 mm
$r_5$ min.	0.6 mm
$d_a$ max.	46 mm
$D_a$ min.	70 mm
$D_a$ max.	72.5 mm
$C_a$ min.	3 mm
$r_a$ max.	1.5 mm
$r_c$ max.	0.6 mm
Basic dynamic load rating C	152 kN
Basic static load rating $C_0$	150 kN
Fatigue load limit $P_u$	16.6 kN
Reference speed	6000 r/min
Limiting speed	9000 r/min
Calculation factor e	0.31
Calculation factor $Y_1$	2.2
Calculation factor $Y_2$	3.3
Calculation factor $Y_0$	2.2
Mass bearing pair	1.06 kg