

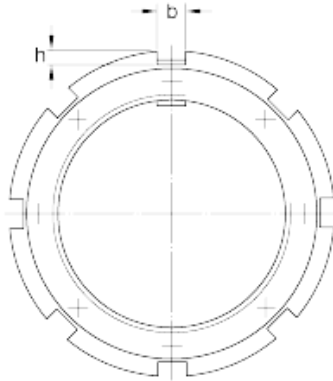

GF BEARING-SINGAPORE LTD.

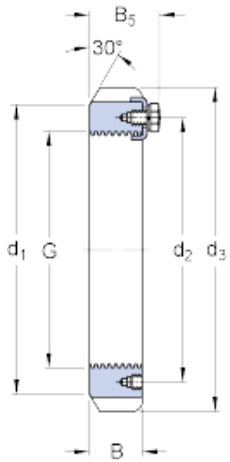

skf HM 30/630 Lock nuts requiring a keyway
(metric)

Bearing No. HM 30/630

G	Tr 630x6
d ₃	730 mm
B	75 mm
d ₁	690 mm
d ₂	658 mm
B ₅	97 mm
b	45 mm
h	20 mm
Mass lock nut	59.7 kg
Associated spanner	TMFN 500-600
Associated eyebolt for handling	M 10
Lock washer / Locking clip	MS 30/630

HM 30/630 Bearing 2D drawings and 3D CAD models