

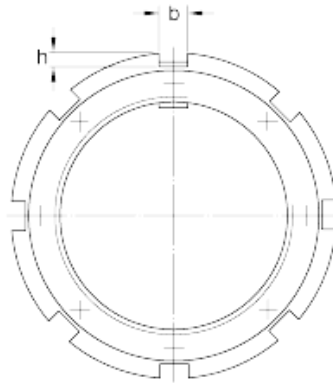

GF BEARING-SINGAPORE LTD.

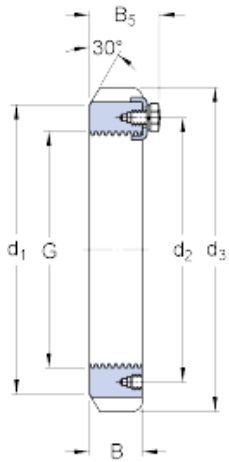

skf HM 31/530 Lock nuts requiring a keyway
(metric)

Bearing No. HM 31/530

G	Tr 530x6
d ₃	670 mm
B	80 mm
d ₁	610 mm
d ₂	575 mm
B ₅	105 mm
b	40 mm
h	23 mm
Mass lock nut	76.8 kg
Associated spanner	TMFN 500-600
Associated eyebolt for handling	M 10
Lock washer / Locking clip	MS 31/530

HM 31/530 Bearing 2D drawings and 3D CAD models