

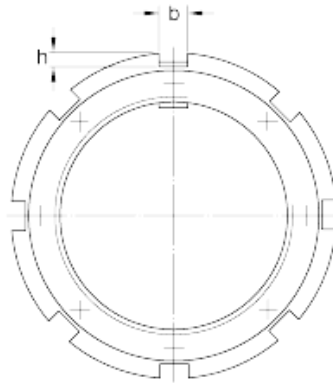

GF BEARING-SINGAPORE LTD.

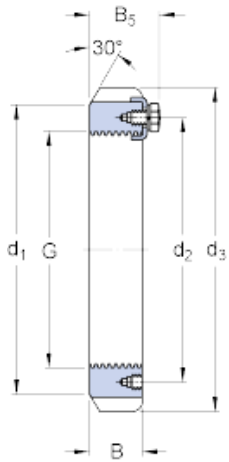

skf HM 3180 Lock nuts requiring a keyway
(metric)

Bearing No. HM 3180

G	Tr 400x5
d ₃	520 mm
B	62 mm
d ₁	460 mm
d ₂	440 mm
B ₅	82 mm
b	32 mm
h	18 mm
Mass lock nut	38.2 kg
Associated spanner	TMFN 64-80
Associated eyebolt for handling	M 10

HM 3180 Bearing 2D drawings and 3D CAD models