

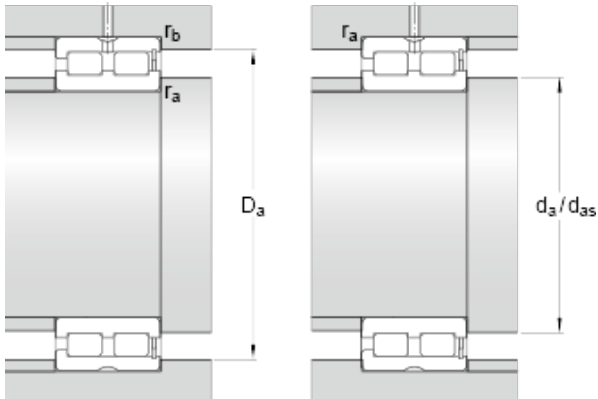

## GF BEARING-SINGAPORE LTD.



340 mm x 520 mm x 243 mm skf NNCF 5068  
CV Double row full complement cylindrical roller  
bearings

Bearing No. NNCF 5068 CV

d	340 mm
D	520 mm
B	243 mm
d <sub>1</sub>	395 mm
D <sub>1</sub>	468 mm
b <sub>1</sub>	9.4 mm
K	5 mm
s max.	11 mm
r <sub>1,2</sub> min.	5 mm
r <sub>3,4</sub> min.	5 mm
d <sub>a</sub> min.	362 mm
d <sub>as</sub>	384 mm
D <sub>a</sub> max.	500 mm
r <sub>a</sub> max.	4 mm
r <sub>b</sub> max.	4 mm
Basic dynamic load rating C	4400 kN
Basic static load rating C <sub>0</sub>	8300 kN
Fatigue load limit P <sub>u</sub>	710 kN
Reference speed	530 r/min
Limiting speed	670 r/min
Calculation factor k <sub>r</sub>	0.5
Mass bearing	185 kg

NNCF 5068 CV Bearing 2D drawings and 3D CAD  
models